

Article number: 20194V20B202SW

Description: E+G

T-angel clamps GN194-V20-B20-2-SW

Measures

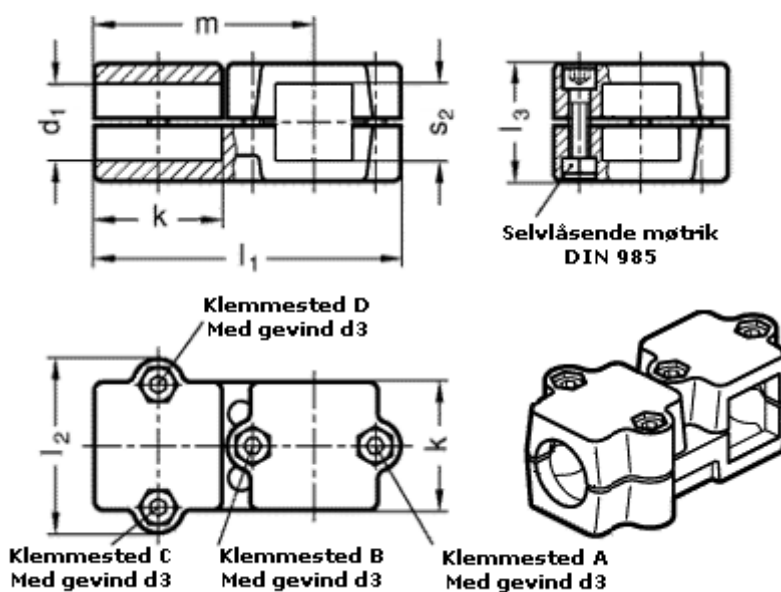

$d_2 = 20$

$d_3 = M 8$

$k = 50$

$l_1 = 120$

$l_2 = 68$

$l_3 = 46$

$m = 85$

$s_1 = 20$